

DATA SHEET



TDA4863J; TDA4863AJ Vertical deflection booster

Product specification
File under Integrated Circuits, IC02

2000 Aug 17

تهیه و توزیع قطعات الکترونیک

Vertical deflection booster

TDA4863J; TDA4863AJ

FEATURES

- Power amplifier with differential inputs
- Output current up to 3 A (p-p)
- High vertical deflection frequency up to 200 Hz
- High linear sawtooth signal amplification
- Flyback generator:
 - TDA4863J: separate adjustable flyback supply voltage up to 60 V
 - TDA4863AJ: internally doubled supply voltage (two supply voltages only for DC-coupled outputs).

GENERAL DESCRIPTION

The TDA4863J and TDA4863AJ are deflection boosters for use in vertical deflection systems for frame frequencies up to 200 Hz.

The TDA4863J needs a separate flyback supply voltage, so the supply voltages are independently adjustable to optimize power consumption and flyback time.

For the TDA4863AJ the flyback supply voltage will be generated internally by doubling the supply voltage and therefore a separate flyback supply voltage is not needed.

Both circuits provide differential input stages and fit well with the TDA485X monitor deflection controller family.

QUICK REFERENCE DATA

Measurements referenced to ground (pin GND).

SYMBOL	PARAMETER	CONDITIONS	MIN.	TYP.	MAX.	UNIT
V_{P1}	supply voltage 1 (pin 1)		9	–	30	V
V_{P2}	supply voltage 2 for vertical output (pin 3)		$V_{P1} - 1$	–	60	V
V_{FB}	flyback supply voltage of TDA4863J (pin 2)		$V_{P1} - 1$	–	60	V
V_{P3}	flyback generator output voltage of TDA4863AJ (pin 2)	$I_5 = -1.5$ A	0	–	$V_{P1} + 2.2$	V
$I_{5(p-p)}$	vertical output current (pin 5) (peak-to-peak value)		–	–	3	A
I_{P1}	supply current 1 (pin 1)	during scan	–	6	10	mA
I_{P2}	quiescent supply current 2 (pin 3)	$I_5 = 0$	–	25	60	mA
V_{INP}	input voltage (pin 7)		1.6	–	$V_{P1} - 0.5$	V
V_{INN}	input voltage (pin 6)		1.6	–	$V_{P1} - 0.5$	V
T_{amb}	ambient temperature		–20	–	+75	°C

ORDERING INFORMATION

TYPE NUMBER	PACKAGE		VERSION
	NAME	DESCRIPTION	
TDA4863J	DBS7P	plastic DIL-bent-SIL power package; 7 leads (lead length 12/11 mm); exposed die pad	SOT524-1
TDA4863AJ			

تهیه و توزیع قطعات الکترونیک

Vertical deflection booster

TDA4863J; TDA4863AJ

BLOCK DIAGRAM

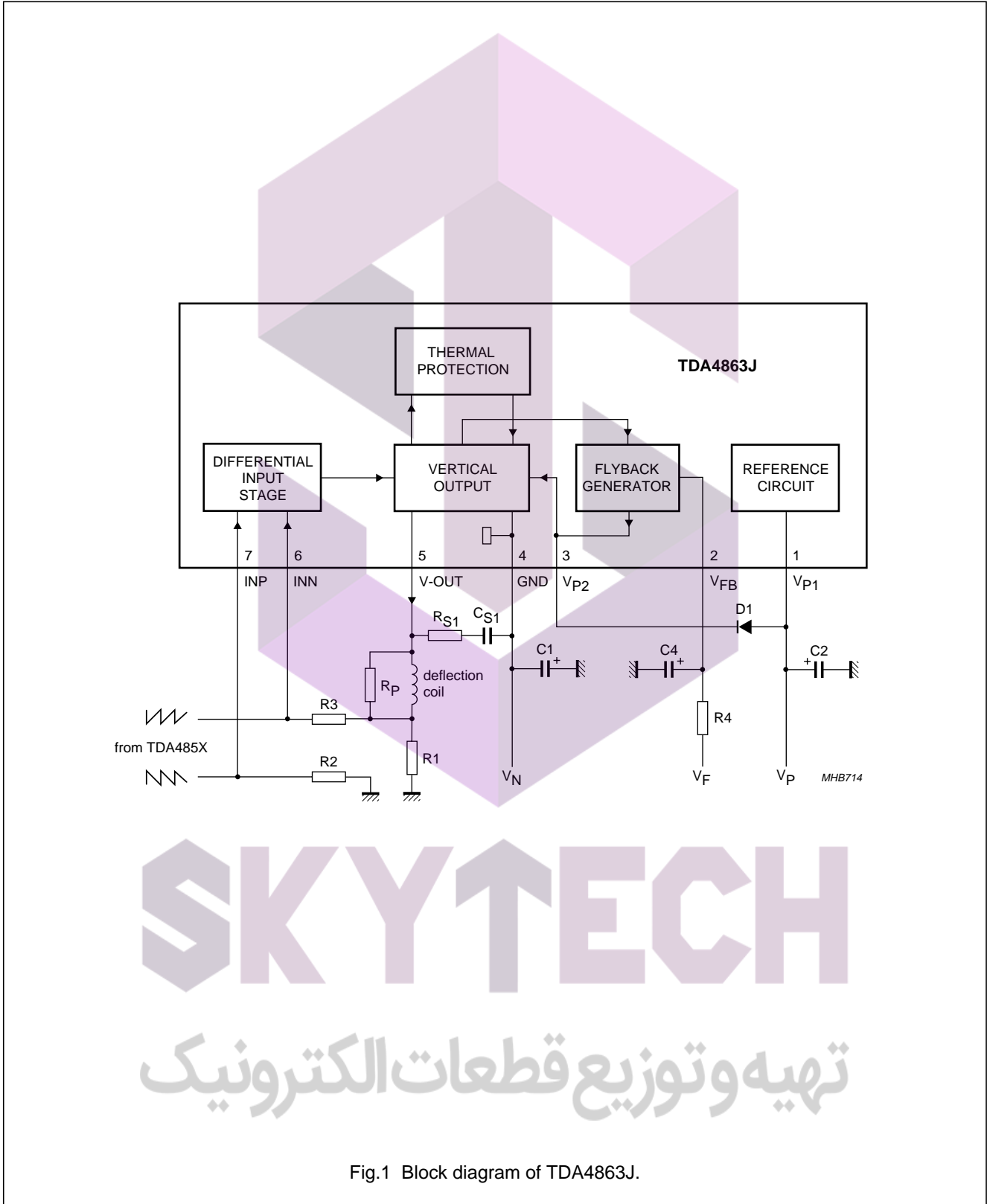
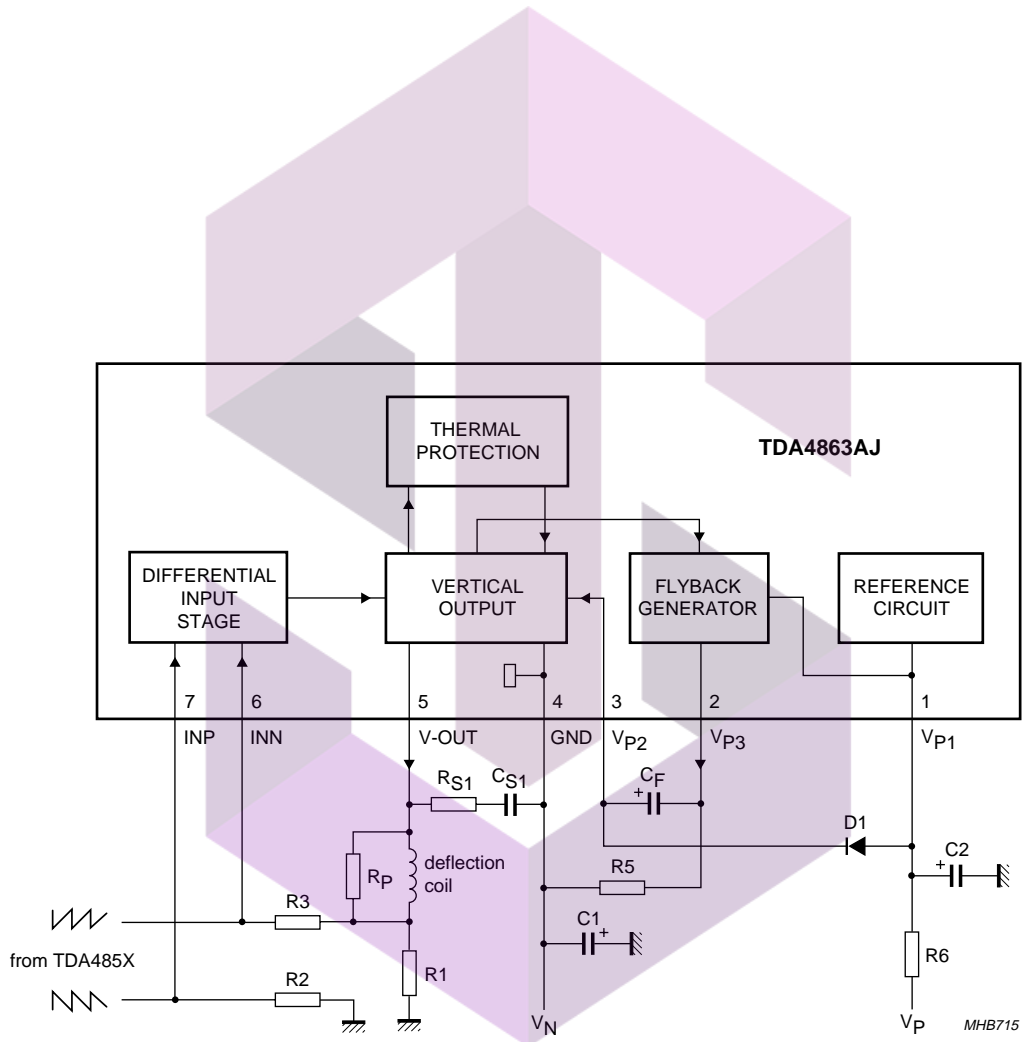

Fig.1 Block diagram of TDA4863J.

Vertical deflection booster

TDA4863J; TDA4863AJ



SKYTECH
 تهیه و توزیع قطعات الکترونیک

Fig.2 Block diagram of TDA4863AJ.

Vertical deflection booster

TDA4863J; TDA4863AJ

PINNING

SYMBOL	PIN		DESCRIPTION
	TDA4863J	TDA4863AJ	
V _{P1}	1	1	positive supply voltage 1
V _{FB}	2	–	flyback supply voltage
V _{P3}	–	2	flyback generator output
V _{P2}	3	3	supply voltage 2 for vertical output
GND	4	4	ground or negative supply voltage
V-OUT	5	5	vertical output
INN	6	6	inverted input of differential input stage
INP	7	7	non-inverted input of differential input stage

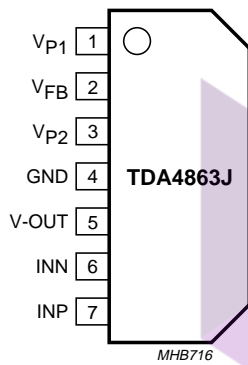

Fig.3 Pin configuration of TDA4863J.

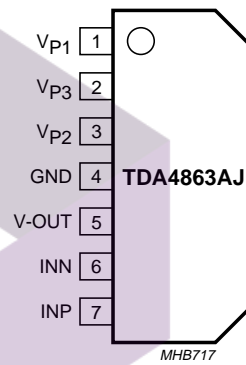

Fig.4 Pin configuration of TDA4863AJ.

SKYTECH

تهیه و توزیع قطعات الکترونیک

Vertical deflection booster

TDA4863J; TDA4863AJ

FUNCTIONAL DESCRIPTION

Both the TDA4863J and TDA4863AJ consist of a differential input stage, a vertical output stage, a flyback generator, a reference circuit and a thermal protection circuit.

The TDA4863J operates with a separate flyback supply voltage (see Fig.1) while the TDA4863AJ generates the flyback voltage internally by doubling the supply voltage (see Fig.2).

Differential input stage

The differential sawtooth input signal (e.g. coming from the deflection controller family TDA485X) is connected to the inputs (inverted signal to pin 6 and non-inverted signal to pin 7). The vertical feedback signal is superimposed on the inverted signal on pin 6.

Vertical output and thermal protection

The vertical output stage is a quasi-complementary class-B amplifier with a high linearity.

The output stage is protected against thermal overshoots. For a junction temperature $T_j > 150\text{ °C}$ this protection will be activated and will reduce then the deflection current (I_5).

Flyback generator

The flyback generator supplies the vertical output stage during flyback.

The TDA4863J is used with separate flyback supply voltage to achieve a short flyback time with minimized power dissipation.

The TDA4863AJ needs a capacitor C_F between pins 2 and 3 (see Fig.2). Capacitor C_F is charged during scan, using the external diode D1 and resistor R5. During flyback the cathode of capacitor C_F is connected to the positive supply voltage and the flyback voltage is then twice the supply voltage. For the TDA4863AJ the resistor R6 in the positive supply line can be used to reduce the power consumption.

In parallel with the deflection coil a damping resistor R_P and an RC combination ($R_{S1} = 5.6\ \Omega$ and $C_{S1} = 100\text{ nF}$) are needed. Furthermore, another additional RC combination ($R_{S2} = 5.6\ \Omega$ and $C_{S2} = 47\text{ to }150\text{ nF}$) can be used to minimize the noise effect and the flyback time (see Figs 9 and 10).

 The logo for SKYTECH, featuring the word "SKYTECH" in a bold, stylized, sans-serif font. The letters are white with a purple outline. The 'S' and 'K' are connected, and the 'Y' has a unique shape. The 'T' is a simple vertical bar. The 'E' and 'C' are also connected. The 'H' is a simple vertical bar.

تهیه و توزیع قطعات الکترونیک

Vertical deflection booster

TDA4863J; TDA4863AJ

LIMITING VALUES

In accordance with the Absolute Maximum Rating System (IEC 60134); voltages referenced to ground (pin 4); unless otherwise specified.

SYMBOL	PARAMETER	CONDITIONS	MIN.	MAX.	UNIT
V_{P1}	supply voltage 1 (pin 1)		–	40	V
V_{P2}	supply voltage 2 (pin 3)		–	60	V
V_{FB}	flyback supply voltage of TDA4863J (pin 2)		–	60	V
V_{P3}	flyback generator output voltage of TDA4863AJ (pin 2)		0	$V_{P1} + 3$	V
$V_{i(6,7)}$	input voltage on pins 6 and 7		–	V_{P1}	V
$V_{o(5)}$	output voltage on pin 5		–	62	V
I_{P2}	supply current 2 (pin 3)		–	± 1.8	A
$I_{o(5)}$	output current (pin 5)	note 1	–	± 1.8	A
I_2	flyback current on pin 2		–	± 1.8	A
T_{stg}	storage temperature		–25	+150	°C
T_{amb}	ambient temperature		–20	+75	°C
T_j	junction temperature	note 1	–	150	°C
V_{es}	electrostatic discharge voltage on all pins	note 2	–300	+300	V

Notes

- Internally limited by thermal protection; will be activated for $T_j \geq 150$ °C.
- Equivalent to discharging a 200 pF capacitor through a 0 Ω series resistor.

THERMAL CHARACTERISTICS

SYMBOL	PARAMETER	CONDITIONS	VALUE	UNIT
$R_{th(j-mb)}$	thermal resistance from junction to mounting base	note 1	6	K/W

Note

- To minimize the thermal resistance from mounting base to heatsink [$R_{th(mb-h)}$] follow the recommended mounting instruction: screw mounting preferred; torque = 40 Ncm; use heatsink compound; isolation plate increases $R_{th(mb-h)}$.



 تهیه و توزیع قطعات الکترونیک

Vertical deflection booster

TDA4863J; TDA4863AJ

CHARACTERISTICS

$V_{P1} = 25 \text{ V}$; $V_4 = 0 \text{ V}$; $T_{\text{amb}} = 25 \text{ }^\circ\text{C}$; voltages referenced to ground (pin 4); unless otherwise specified.

SYMBOL	PARAMETER	CONDITIONS	MIN.	TYP.	MAX.	UNIT
Supplies						
V_{P1}	supply voltage 1 (pin 1)		9	–	30	V
V_{P2}	supply voltage 2 (pin 3)		$V_{P1} - 1$	–	60	V
V_{FB}	flyback supply voltage of TDA4863J (pin 2)		$V_{P1} - 1$	–	60	V
V_{P3}	flyback generator output voltage of TDA4863AJ (pin 2)	$I_5 = -1.5 \text{ A}$	0	–	$V_{P1} + 2.2$	V
I_{P1}	supply current 1 (pin 1)	during scan	–	6	10	mA
I_{P2}	quiescent supply current 2 (pin 3)	$I_5 = 0$	–	25	60	mA
Differential input stage						
V_{INP}	input voltage (pin 7)		1.6	–	$V_{P1} - 0.5$	V
V_{INN}	input voltage (pin 6)		1.6	–	$V_{P1} - 0.5$	V
I_{INP}	input quiescent current (pin 7)		–	–100	–500	nA
I_{INN}	input quiescent current (pin 6)		–	–100	–500	nA
Flyback generator						
I_2	current during flyback		–	–	± 1.5	A
V_{3-2}	voltage drop during flyback of TDA4863J reverse	$I_5 = -1 \text{ A}$	–	–1.5	–	V
		$I_5 = -1.5 \text{ A}$	–	–2	–	V
	forward	$I_5 = 1 \text{ A}$	–	2.2	–	V
		$I_5 = 1.5 \text{ A}$	–	2.5	–	V
V_{2-1}	voltage drop during flyback of TDA4863AJ reverse	$I_5 = -1 \text{ A}$	–	–1.5	–	V
		$I_5 = -1.5 \text{ A}$	–	–2	–	V
	forward	$I_5 = 1 \text{ A}$	–	2.2	–	V
		$I_5 = 1.5 \text{ A}$	–	2.5	–	V
Vertical output stage; see Fig.5						
I_5	vertical deflection output current		–	–	± 1.5	A
$I_{5(p-p)}$	vertical deflection output current on pin 5 (peak-to-peak value)		–	–	3	A
V_{5-4}	output saturation voltage to ground	$I_5 = 1 \text{ A}$	–	1.4	1.7	V
		$I_5 = 1.5 \text{ A}$	–	1.8	2.3	V
V_{5-3}	output saturation voltage to V_{P2}	$I_5 = 1 \text{ A}$	–2.3	–2	–	V
		$I_5 = 1.5 \text{ A}$	–2.8	–2.3	–	V
LIN	non-linearity of output signal	note 1	–	–	1	%

Note

1. Deviation of the output slope at a constant input slope.

Vertical deflection booster

TDA4863J; TDA4863AJ

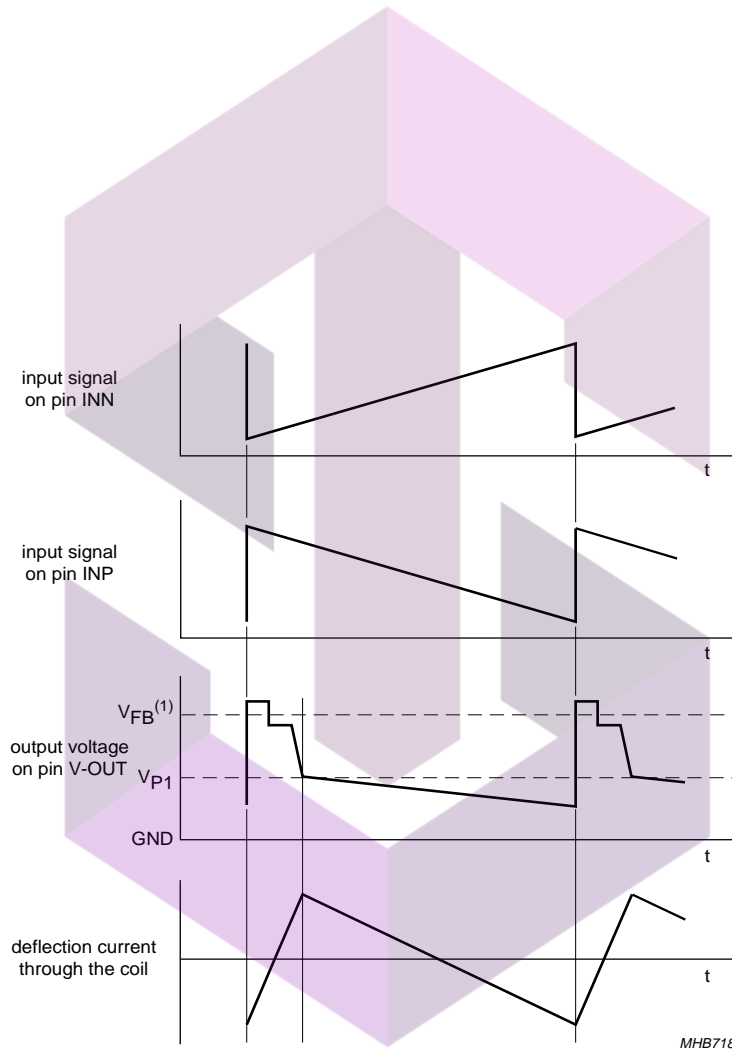

SKYTECH

تهیه و توزیع قطعات الکترونیک

(1) V_{FB} for TDA4863J; $2V_{P1}$ for TDA4863AJ.

Fig.5 Timing diagram.

Vertical deflection booster

TDA4863J; TDA4863AJ

INTERNAL PIN CONFIGURATION

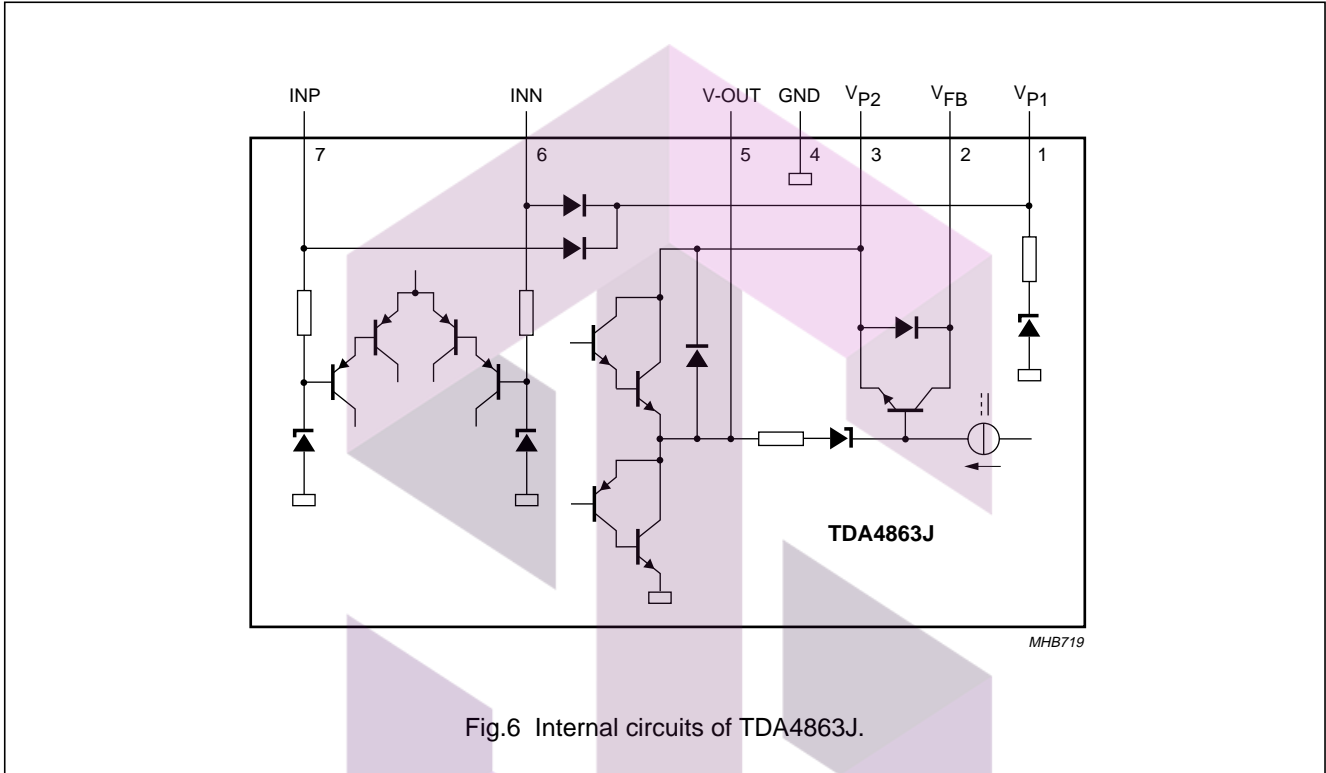

Fig.6 Internal circuits of TDA4863J.

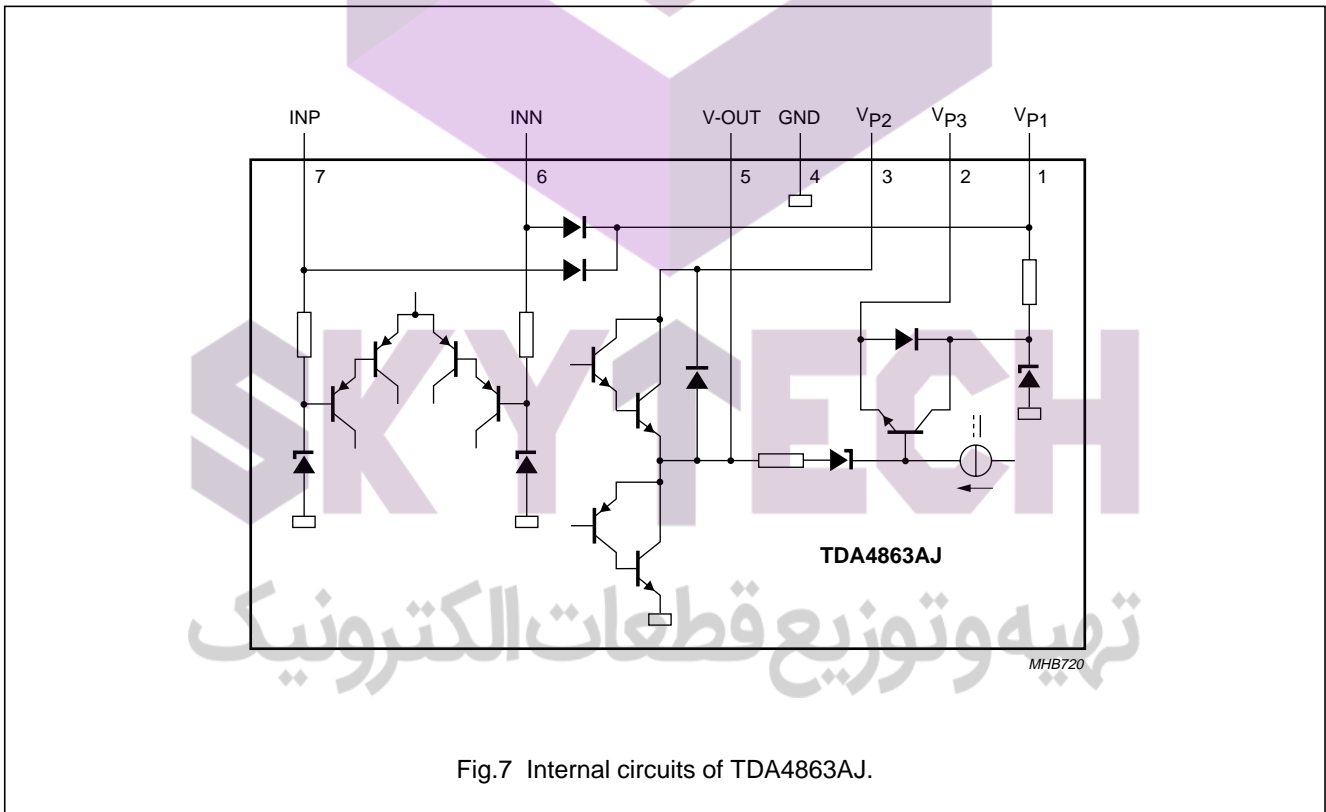

Fig.7 Internal circuits of TDA4863AJ.

Vertical deflection booster

TDA4863J; TDA4863AJ

APPLICATION INFORMATION

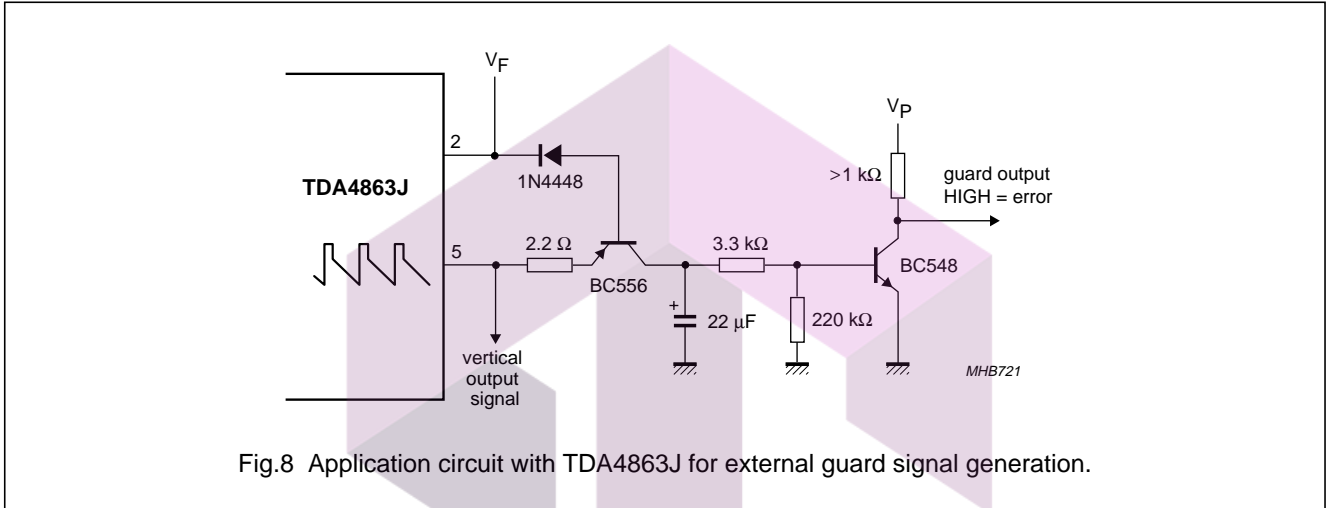
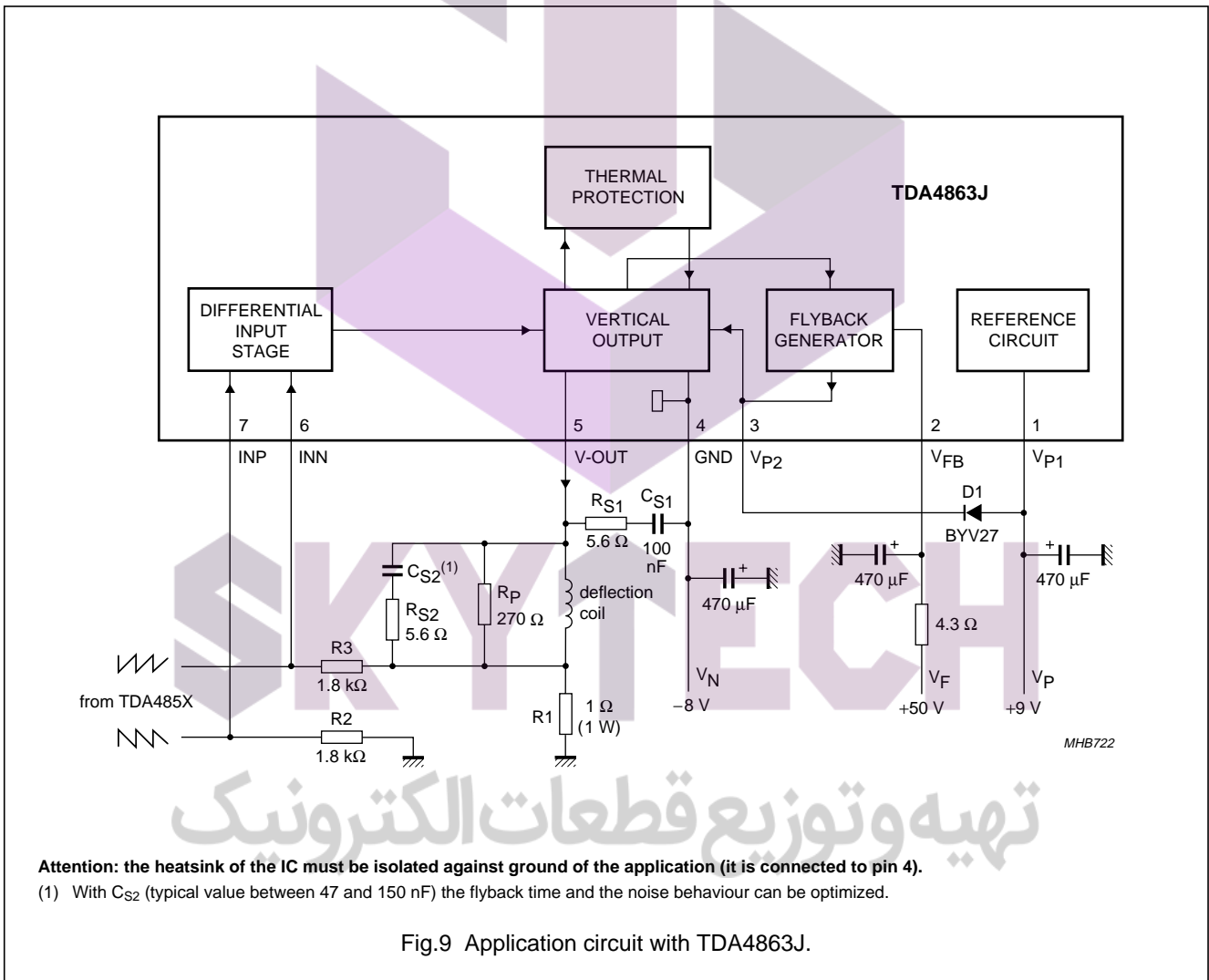

Fig.8 Application circuit with TDA4863J for external guard signal generation.



Attention: the heatsink of the IC must be isolated against ground of the application (it is connected to pin 4).

(1) With CS2 (typical value between 47 and 150 nF) the flyback time and the noise behaviour can be optimized.

Fig.9 Application circuit with TDA4863J.

Vertical deflection booster

TDA4863J; TDA4863AJ

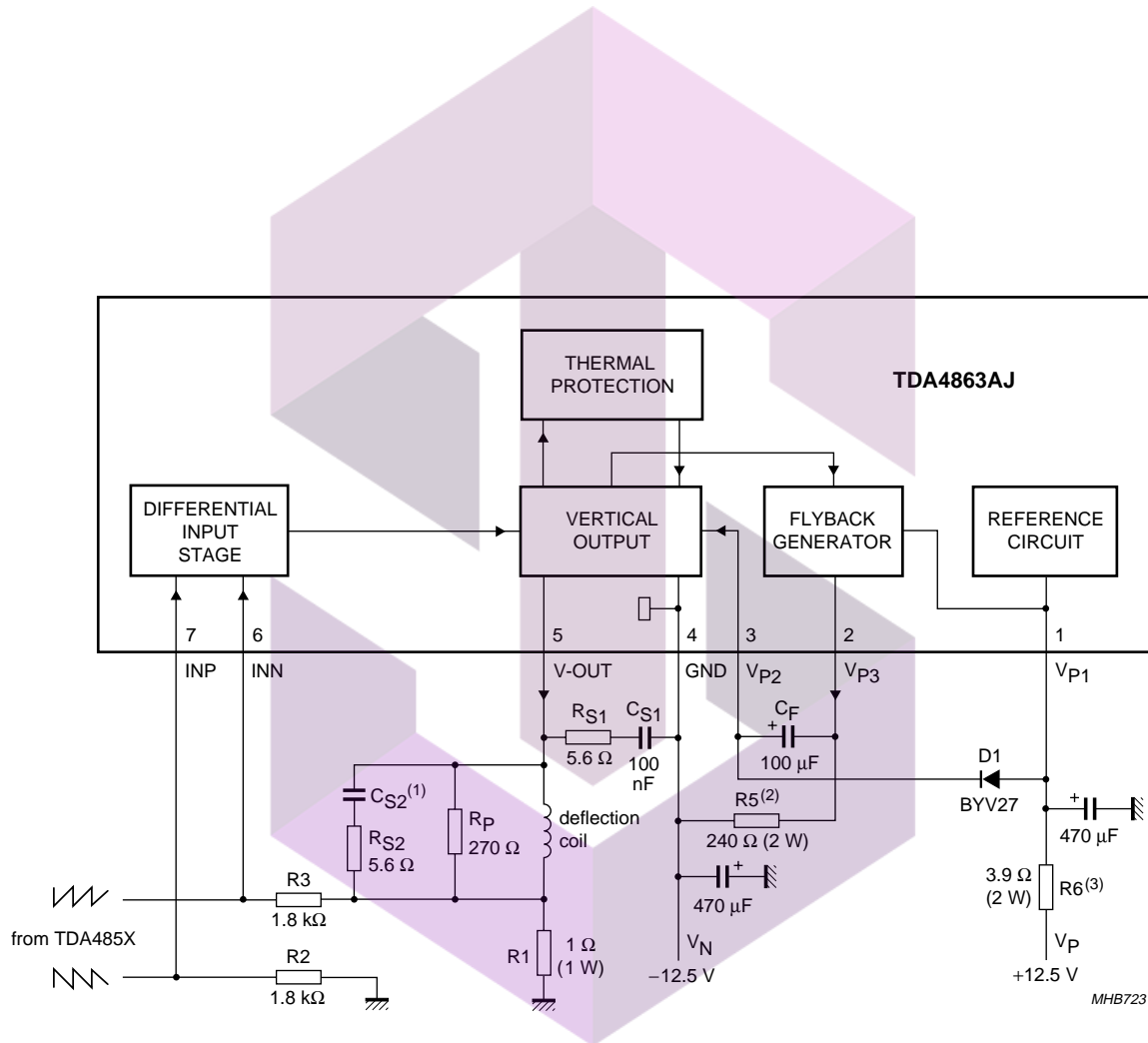

Attention: the heatsink of the IC must be isolated against ground of the application (it is connected to pin 4).

- (1) With C_{S2} (typical value between 47 and 150 nF) the flyback time and the noise behaviour can be optimized.
- (2) With $R5$ capacitor C_F will be charged during scan and the value (typical value between 150 and 270 Ω) depends on I_{defl} , t_{fb} and C_F .
- (3) $R6$ reduces the power dissipation of the IC. The maximum possible value depends on the application.

Fig.10 Application circuit with TDA4863AJ.

Vertical deflection booster

TDA4863J; TDA4863AJ

Example for both TDA4863J and TDA4863AJ

Table 1 Values given from application

SYMBOL	VALUE	UNIT
$I_{\text{defl(max)}}$	0.71	A
L_{deflcoil}	6	mH
R_{deflcoil}	6	Ω
R_P	270	Ω
R1	1	Ω
R2	1.8	k Ω
R3	1.8	k Ω
$V_{\text{FB}}^{(1)}$	50	V
T_{amb}	60	$^{\circ}\text{C}$
T_{deflcoil}	75	$^{\circ}\text{C}$
$R_{\text{th(j-mb)}}$	6	K/W
$R_{\text{th(mb-amb)}}$	8	K/W

Note

- For TDA4863J only.

Table 2 Calculated values

SYMBOL	VALUE		UNIT
	TDA4863J	TDA4863AJ	
V_{P1}	9	12.5	V
V_N	-8	-12.5	V
P_{tot}	3.2	4.4	W
P_{defl}	1.2	1.2	W
P_{IC}	2	3.2	W
$R_{\text{th(tot)}}$	14	14	K/W
$T_{\text{j(max)}}$	88	105	$^{\circ}\text{C}$

V_{P1} , V_N and V_{FB} are referenced to ground of application; voltages are calculated with +10% tolerances.

Calculation formulae for supply voltages:

$$V_{P1} = -V_{5-3} + (R1 + R_{\text{deflcoil}}) \times I_{\text{defl(max)}} - U'_L + U_{D1}$$

$$V_N = V_{5-4} + (R1 + R_{\text{deflcoil}}) \times I_{\text{defl(max)}} + U'_L$$

where

$$U'_L = L_{\text{deflcoil}} \times 2I_{\text{defl(max)}} \times f_v$$

f_v = vertical deflection frequency

U_{D1} = forward voltage drop across D1.

Calculation formulae for power consumption:

$$P_{\text{IC}} = P_{\text{tot}} - P_{\text{defl}}$$

$$P_{\text{tot}} = (V_{P1} - U_{D1}) \times \frac{I_{\text{defl(max)}}}{4} + V_N \times \frac{I_{\text{defl(max)}}}{4} + (V_{P1} - V_N) \times 0.01 \text{ A} + 0.2 \text{ W}$$

$$P_{\text{defl}} = \frac{R_{\text{deflcoil}} + R1}{3} \times I_{\text{defl(max)}}^2$$

where

P_{IC} = power dissipation of the IC

P_{tot} = total power dissipation

P_{defl} = power dissipation of the deflection coil.

Calculation formulae for maximum required thermal resistance for the heatsink at $T_{\text{j(max)}} = 110 \text{ }^{\circ}\text{C}$:

$$R_{\text{th(mb-amb)}} = \left(\frac{T_{\text{j(max)}} - T_{\text{amb}}}{P_{\text{IC}}} \right) - R_{\text{th(j-mb)}} = 19 \text{ K/W (max.)}$$

Table 3 t_{flb} as a function of V_{FB} for TDA4863J

t_{flb} (μs)	V_{FB} (V)
350	30
250	40
210	50

Table 4 t_{flb} as a function of V_{P1} and V_N for TDA4863AJ

t_{flb} (μs)	V_{P1} (V)	V_N (V)	P_{IC} (W)	R6 (Ω)
360	10	-10	2.5	1
290	12.5	-12.5	3.2	3.9
240	15	-15	3.9	6.8

Vertical deflection booster

TDA4863J; TDA4863AJ

PACKAGE OUTLINE

DBS7P: plastic DIL-bent-SIL power package; 7 leads (lead length 12/11 mm); exposed die pad

SOT524-1

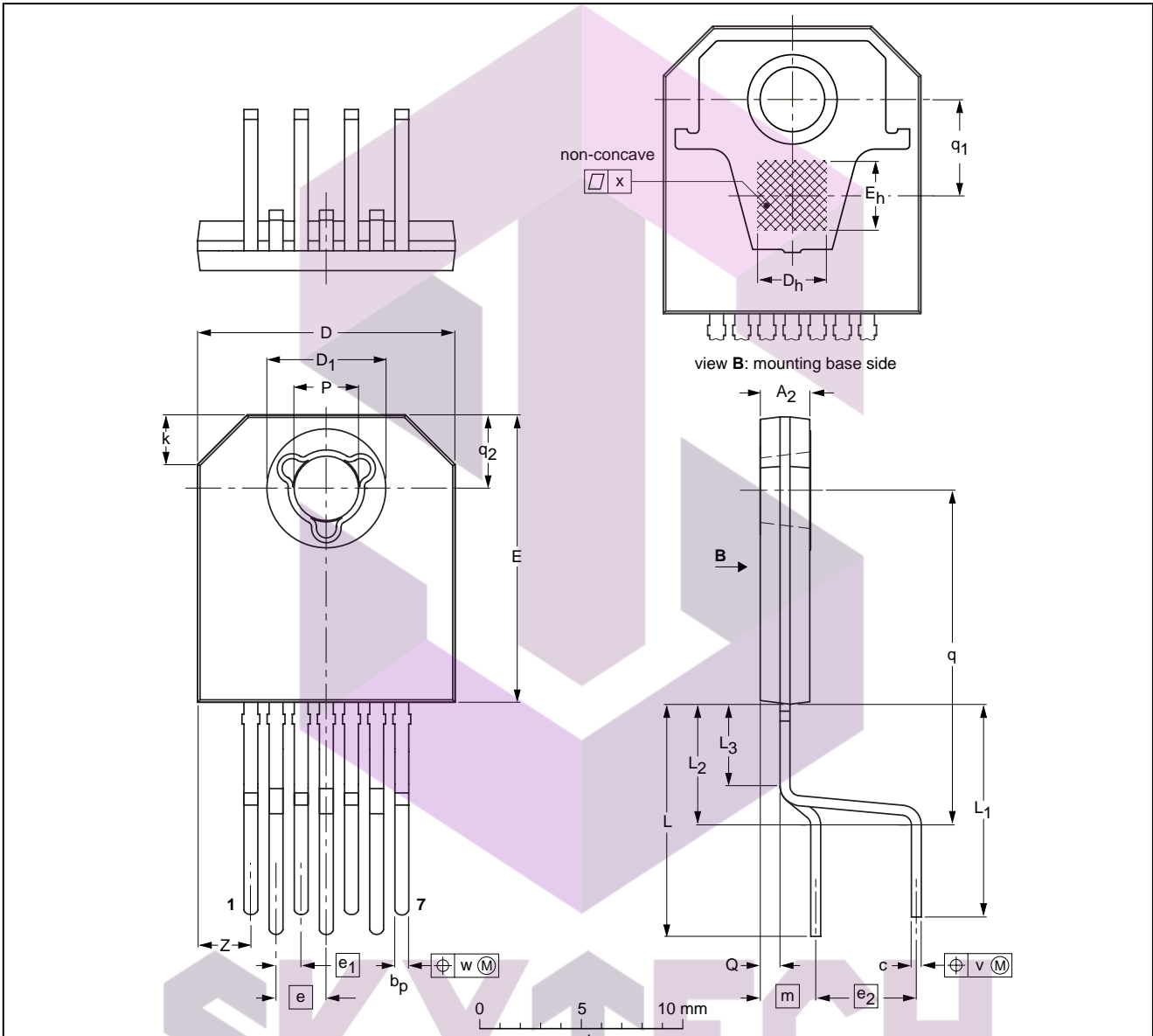

DIMENSIONS (mm are the original dimensions)

UNIT	A ₂ ⁽²⁾	b _p	c	D ⁽¹⁾	D ₁ ⁽²⁾	D _h	E ⁽¹⁾	E _h	e	e ₁	e ₂	k	L	L ₁	L ₂	L ₃	m	P	Q	q	q ₁	q ₂	v	w	x	z ⁽¹⁾
mm	2.7 2.3	0.80 0.65	0.58 0.48	13.2 12.8	6.2 5.8	3.5	14.7 14.3	3.5	2.54	1.27	5.08	3.0 2.0	12.4 11.0	11.4 10.0	6.7 5.5	4.5 3.7	2.8	3.4 3.1	1.15 0.85	17.5 16.3	4.85	3.8 3.6	0.8	0.3	0.02	2.92 2.37

- Notes
1. Plastic or metal protrusions of 0.25 mm maximum per side are not included.
 2. Plastic surface within circle area D₁ may protrude 0.04 mm maximum.

OUTLINE VERSION	REFERENCES			EUROPEAN PROJECTION	ISSUE DATE
	IEC	JEDEC	EIAJ		
SOT524-1					98-11-12-00-07-03

Vertical deflection booster

TDA4863J; TDA4863AJ

SOLDERING

Introduction to soldering through-hole mount packages

This text gives a brief insight to wave, dip and manual soldering. A more in-depth account of soldering ICs can be found in our “Data Handbook IC26; Integrated Circuit Packages” (document order number 9398 652 90011).

Wave soldering is the preferred method for mounting of through-hole mount IC packages on a printed-circuit board.

Soldering by dipping or by solder wave

The maximum permissible temperature of the solder is 260 °C; solder at this temperature must not be in contact with the joints for more than 5 seconds.

The total contact time of successive solder waves must not exceed 5 seconds.

The device may be mounted up to the seating plane, but the temperature of the plastic body must not exceed the specified maximum storage temperature ($T_{stg(max)}$). If the printed-circuit board has been pre-heated, forced cooling may be necessary immediately after soldering to keep the temperature within the permissible limit.

Manual soldering

Apply the soldering iron (24 V or less) to the lead(s) of the package, either below the seating plane or not more than 2 mm above it. If the temperature of the soldering iron bit is less than 300 °C it may remain in contact for up to 10 seconds. If the bit temperature is between 300 and 400 °C, contact may be up to 5 seconds.

Suitability of through-hole mount IC packages for dipping and wave soldering methods

PACKAGE	SOLDERING METHOD	
	DIPPING	WAVE
DBS, DIP, HDIP, SDIP, SIL	suitable	suitable ⁽¹⁾

Note

1. For SDIP packages, the longitudinal axis must be parallel to the transport direction of the printed-circuit board.



Vertical deflection booster

TDA4863J; TDA4863AJ

DATA SHEET STATUS

DATA SHEET STATUS	PRODUCT STATUS	DEFINITIONS ⁽¹⁾
Objective specification	Development	This data sheet contains the design target or goal specifications for product development. Specification may change in any manner without notice.
Preliminary specification	Qualification	This data sheet contains preliminary data, and supplementary data will be published at a later date. Philips Semiconductors reserves the right to make changes at any time without notice in order to improve design and supply the best possible product.
Product specification	Production	This data sheet contains final specifications. Philips Semiconductors reserves the right to make changes at any time without notice in order to improve design and supply the best possible product.

Note

1. Please consult the most recently issued data sheet before initiating or completing a design.

DEFINITIONS

Short-form specification — The data in a short-form specification is extracted from a full data sheet with the same type number and title. For detailed information see the relevant data sheet or data handbook.

Limiting values definition — Limiting values given are in accordance with the Absolute Maximum Rating System (IEC 60134). Stress above one or more of the limiting values may cause permanent damage to the device.

These are stress ratings only and operation of the device at these or at any other conditions above those given in the Characteristics sections of the specification is not implied. Exposure to limiting values for extended periods may affect device reliability.

Application information — Applications that are described herein for any of these products are for illustrative purposes only. Philips Semiconductors make no representation or warranty that such applications will be suitable for the specified use without further testing or modification.

DISCLAIMERS

Life support applications — These products are not designed for use in life support appliances, devices, or systems where malfunction of these products can reasonably be expected to result in personal injury. Philips Semiconductors customers using or selling these products for use in such applications do so at their own risk and agree to fully indemnify Philips Semiconductors for any damages resulting from such application.

Right to make changes — Philips Semiconductors reserves the right to make changes, without notice, in the products, including circuits, standard cells, and/or software, described or contained herein in order to improve design and/or performance. Philips Semiconductors assumes no responsibility or liability for the use of any of these products, conveys no licence or title under any patent, copyright, or mask work right to these products, and makes no representations or warranties that these products are free from patent, copyright, or mask work right infringement, unless otherwise specified.

تهیه و توزیع قطعات الکترونیک

Vertical deflection booster

TDA4863J; TDA4863AJ

NOTES



SKYTECH

تهیه و توزیع قطعات الکترونیک

Vertical deflection booster

TDA4863J; TDA4863AJ

NOTES



SKYTECH

تهیه و توزیع قطعات الکترونیک

Vertical deflection booster

TDA4863J; TDA4863AJ

NOTES



SKYTECH

تهیه و توزیع قطعات الکترونیک

Philips Semiconductors – a worldwide company

Argentina: see South America

Australia: 3 Figtree Drive, HOMEBUSH, NSW 2140,
Tel. +61 2 9704 8141, Fax. +61 2 9704 8139

Austria: Computerstr. 6, A-1101 WIEN, P.O. Box 213,
Tel. +43 1 60 101 1248, Fax. +43 1 60 101 1210

Belarus: Hotel Minsk Business Center, Bld. 3, r. 1211, Volodarski Str. 6,
220050 MINSK, Tel. +375 172 20 0733, Fax. +375 172 20 0773

Belgium: see The Netherlands

Brazil: see South America

Bulgaria: Philips Bulgaria Ltd., Energoproject, 15th floor,
51 James Bourchier Blvd., 1407 SOFIA,
Tel. +359 2 68 9211, Fax. +359 2 68 9102

Canada: PHILIPS SEMICONDUCTORS/COMPONENTS,
Tel. +1 800 234 7381, Fax. +1 800 943 0087

China/Hong Kong: 501 Hong Kong Industrial Technology Centre,
72 Tat Chee Avenue, Kowloon Tong, HONG KONG,
Tel. +852 2319 7888, Fax. +852 2319 7700

Colombia: see South America

Czech Republic: see Austria

Denmark: Sydhavnsgade 23, 1780 COPENHAGEN V,
Tel. +45 33 29 3333, Fax. +45 33 29 3905

Finland: Sinikalliontie 3, FIN-02630 ESPOO,
Tel. +358 9 615 800, Fax. +358 9 6158 0920

France: 51 Rue Carnot, BP317, 92156 SURESNES Cedex,
Tel. +33 1 4099 6161, Fax. +33 1 4099 6427

Germany: Hammerbrookstraße 69, D-20097 HAMBURG,
Tel. +49 40 2353 60, Fax. +49 40 2353 6300

Hungary: see Austria

India: Philips INDIA Ltd, Band Box Building, 2nd floor,
254-D, Dr. Annie Besant Road, Worli, MUMBAI 400 025,
Tel. +91 22 493 8541, Fax. +91 22 493 0966

Indonesia: PT Philips Development Corporation, Semiconductors Division,
Gedung Philips, Jl. Buncit Raya Kav.99-100, JAKARTA 12510,
Tel. +62 21 794 0040 ext. 2501, Fax. +62 21 794 0080

Ireland: Newstead, Clonskeagh, DUBLIN 14,
Tel. +353 1 7640 000, Fax. +353 1 7640 200

Israel: RAPAC Electronics, 7 Kehilat Saloniki St, PO Box 18053,
TEL AVIV 61180, Tel. +972 3 645 0444, Fax. +972 3 649 1007

Italy: PHILIPS SEMICONDUCTORS, Via Casati, 23 - 20052 MONZA (MI),
Tel. +39 039 203 6838, Fax +39 039 203 6800

Japan: Philips Bldg 13-37, Kohnan 2-chome, Minato-ku,
TOKYO 108-8507, Tel. +81 3 3740 5130, Fax. +81 3 3740 5057

Korea: Philips House, 260-199 Itaewon-dong, Yongsan-ku, SEOUL,
Tel. +82 2 709 1412, Fax. +82 2 709 1415

Malaysia: No. 76 Jalan Universiti, 46200 PETALING JAYA, SELANGOR,
Tel. +60 3 750 5214, Fax. +60 3 757 4880

Mexico: 5900 Gateway East, Suite 200, EL PASO, TEXAS 79905,
Tel. +9-5 800 234 7381, Fax +9-5 800 943 0087

Middle East: see Italy

Netherlands: Postbus 90050, 5600 PB EINDHOVEN, Bldg. VB,
Tel. +31 40 27 82785, Fax. +31 40 27 88399

New Zealand: 2 Wagener Place, C.P.O. Box 1041, AUCKLAND,
Tel. +64 9 849 4160, Fax. +64 9 849 7811

Norway: Box 1, Manglerud 0612, OSLO,
Tel. +47 22 74 8000, Fax. +47 22 74 8341

Pakistan: see Singapore

Philippines: Philips Semiconductors Philippines Inc.,
106 Valero St. Salcedo Village, P.O. Box 2108 MCC, MAKATI,
Metro MANILA, Tel. +63 2 816 6380, Fax. +63 2 817 3474

Poland: Al.Jerozolimskie 195 B, 02-222 WARSAW,
Tel. +48 22 5710 000, Fax. +48 22 5710 001

Portugal: see Spain

Romania: see Italy

Russia: Philips Russia, Ul. Usatcheva 35A, 119048 MOSCOW,
Tel. +7 095 755 6918, Fax. +7 095 755 6919

Singapore: Lorong 1, Toa Payoh, SINGAPORE 319762,
Tel. +65 350 2538, Fax. +65 251 6500

Slovakia: see Austria

Slovenia: see Italy

South Africa: S.A. PHILIPS Pty Ltd., 195-215 Main Road Martindale,
2092 JOHANNESBURG, P.O. Box 58088 Newville 2114,
Tel. +27 11 471 5401, Fax. +27 11 471 5398

South America: Al. Vicente Pinzon, 173, 6th floor,
04547-130 SÃO PAULO, SP, Brazil,
Tel. +55 11 821 2333, Fax. +55 11 821 2382

Spain: Balmes 22, 08007 BARCELONA,
Tel. +34 93 301 6312, Fax. +34 93 301 4107

Sweden: Kottbygatan 7, Akalla, S-16485 STOCKHOLM,
Tel. +46 8 5985 2000, Fax. +46 8 5985 2745

Switzerland: Allmendstrasse 140, CH-8027 ZÜRICH,
Tel. +41 1 488 2741 Fax. +41 1 488 3263

Taiwan: Philips Semiconductors, 5F, No. 96, Chien Kuo N. Rd., Sec. 1,
TAIPEI, Taiwan Tel. +886 2 2134 2451, Fax. +886 2 2134 2874

Thailand: PHILIPS ELECTRONICS (THAILAND) Ltd.,
60/14 MOO 11, Bangna Trad Road KM. 3, Bagna, BANGKOK 10260,
Tel. +66 2 361 7910, Fax. +66 2 398 3447

Turkey: Yukari Dudullu, Org. San. Blg., 2.Cad. Nr. 28 81260 Umraniye,
ISTANBUL, Tel. +90 216 522 1500, Fax. +90 216 522 1813

Ukraine: PHILIPS UKRAINE, 4 Patrice Lumumba str., Building B, Floor 7,
252042 KIEV, Tel. +380 44 264 2776, Fax. +380 44 268 0461

United Kingdom: Philips Semiconductors Ltd., 276 Bath Road, Hayes,
MIDDLESEX UB3 5BX, Tel. +44 208 730 5000, Fax. +44 208 754 8421

United States: 811 East Arques Avenue, SUNNYVALE, CA 94088-3409,
Tel. +1 800 234 7381, Fax. +1 800 943 0087

Uruguay: see South America

Vietnam: see Singapore

Yugoslavia: PHILIPS, Trg N. Pasica 5/v, 11000 BEOGRAD,
Tel. +381 11 3341 299, Fax.+381 11 3342 553

For all other countries apply to: Philips Semiconductors,
Marketing Communications, Building BE-p, P.O. Box 218, 5600 MD EINDHOVEN,
The Netherlands, Fax. +31 40 27 24825

Internet: <http://www.semiconductors.philips.com>

© Philips Electronics N.V. 2000

SCA 70

All rights are reserved. Reproduction in whole or in part is prohibited without the prior written consent of the copyright owner.

The information presented in this document does not form part of any quotation or contract, is believed to be accurate and reliable and may be changed without notice. No liability will be accepted by the publisher for any consequence of its use. Publication thereof does not convey nor imply any license under patent- or other industrial or intellectual property rights.

Printed in The Netherlands

753504/01/pp20

Date of release: 2000 Aug 17

Document order number: 9397 750 07125

**Philips
Semiconductors**



PHILIPS

Let's make things better.